

Parts List

Dimensions

Hardware Included



5/16" x 1" Machine Bolt



5/16" Washer



5/16" Kep Nut

Tools Required

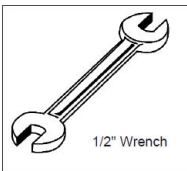

1/2" Wrench

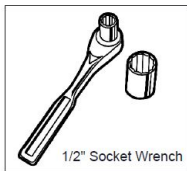

1/2" Socket Wrench

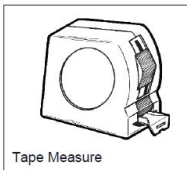

Tape Measure

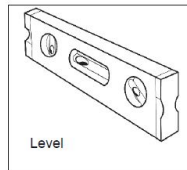

Level

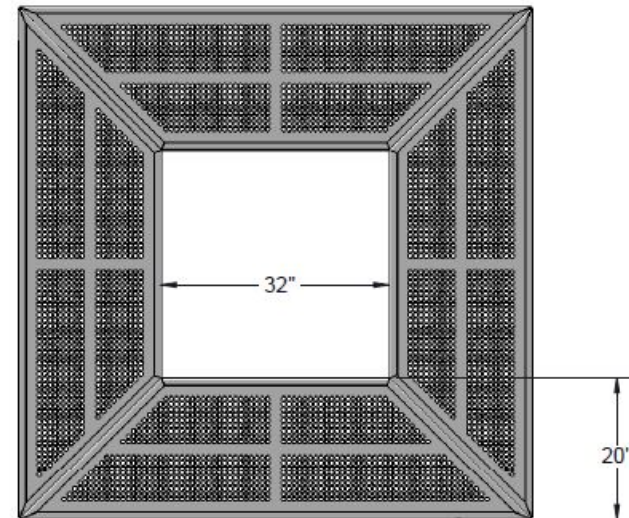

WARRANTY: OCCOutdoors, Inc. guarantees all items for one full year to be free of defects in workmanship or materials when installed and maintained properly. We agree to repair or replace, any items determined to be defective. Items specifically not covered by this warranty include vandalism, manmade or natural disasters, lack of maintenance, normal weathering or wear and tear due to public abuse.

NOTES:

1. INSTALLATION TO BE COMPLETED IN ACCORDANCE WITH MANUFACTURER'S SPECIFICATIONS.
2. ALL DIMENSIONS ARE CONSIDERED TRUE AND REFLECT MANUFACTURER'S SPECIFICATIONS
3. DO NOT SCALE DRAWING.

This document contains OCC Outdoors Proprietary Information. No intellectual copyright or license is granted by OCC Outdoors in connection with it. It is delivered on the express condition that the document and the information contained in it shall be treated as confidential, shall not be used for and purpose other than that for which it is hereby delivered (the use and maintenance of the product supplied). It shall not be disclosed in whole or part to third parties and shall not be duplicated in any manner without OCC Outdoors's prior approval.

OCC Outdoors Products

PH: 1-800-821-7670

EMAIL - occontact@occoutdoors.com

Fax: 1-317-862-9422

OCC-934SM-P6 6' Rectangular Bench,
Perforated Pattern, Surface Mount

Part #: OCC-934S -P6

Date: 03/04/2016 Page 1 of 2

Assembly Instructions

Step 1

Attach two of the 6' Benches to a 934 Leg using specified hardware as shown Repeat this using the other two benches

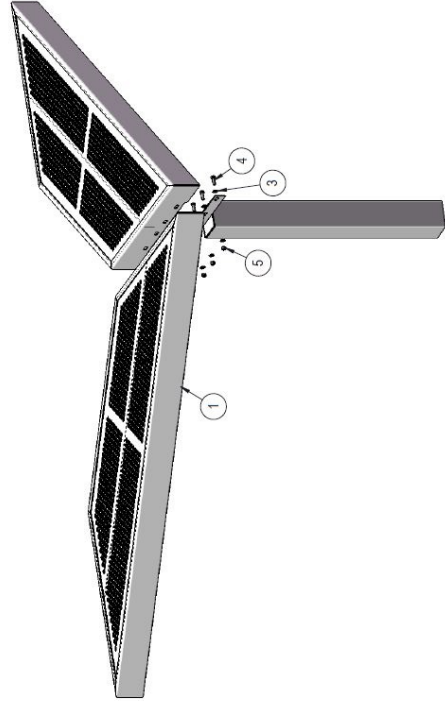

Step 2

Attach the two halves of the square together using the other two legs and hardware.

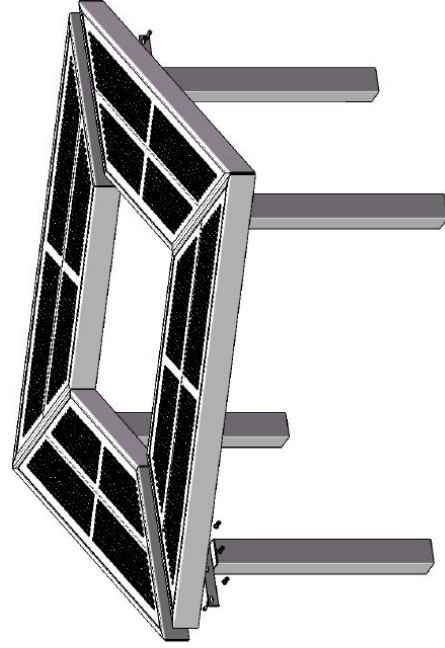

Take note of leg position.

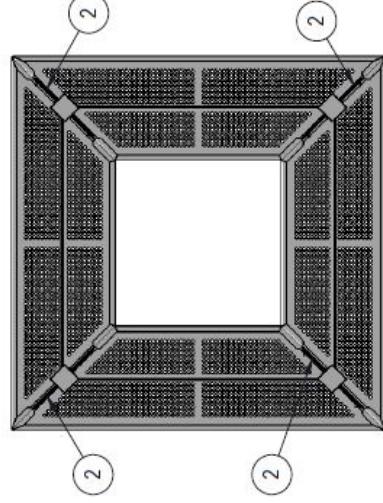

Footings

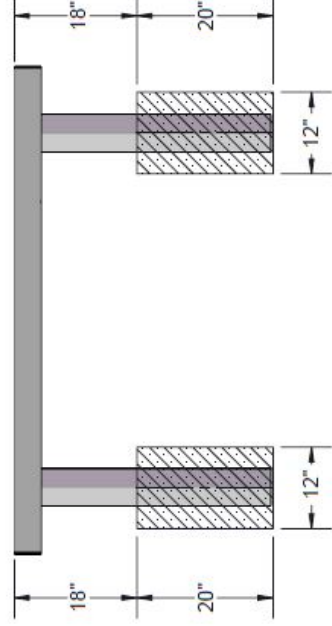
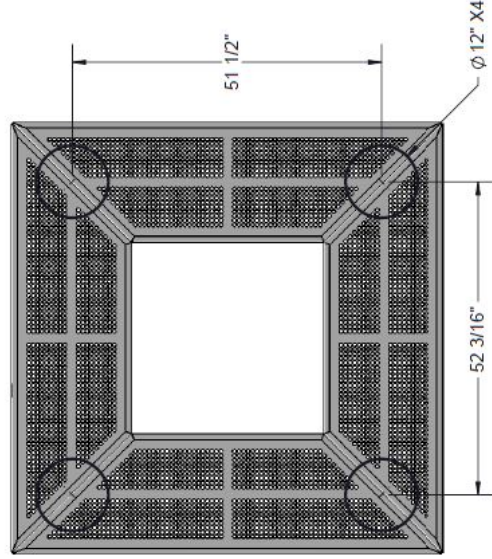

Estimated Required Concrete:
14 - 50lb bags of Concrete Mix