

**Parts List**

**Mounting Instructions:**  
**Recommended Surface Mount Hardware: 3/8" x 3-1/2" Concrete Expansion Anchor Bolts. (Not Included)**

**Dimensions**

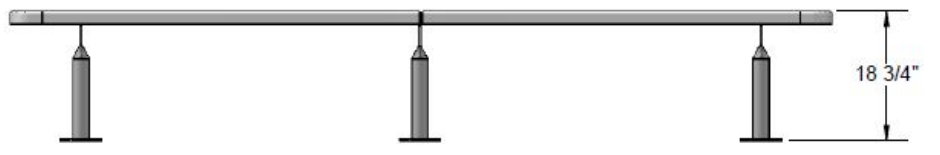
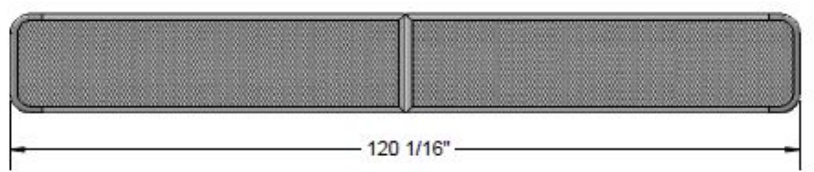

**Hardware Included**

ITEM NO.	PartNo	DESCRIPTION	QTY
1	T-DV60-S	10' Deluxe Expanded Seat	2
2	P-V942SM	942SM VINYL LEG	3
3	33-02-0007	5/16" Flat Washer (SS)	12
4	33-05-0029	5/16" x 1" Machine Bolt (SS)	6
5	33-03-0012	5/16" Kep Nut (SS)	6

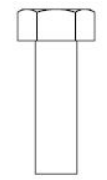

5/16" x 1" Machine Bolt

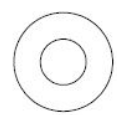

5/16" Washer



5/16" Kep Nut

**Tools Required**

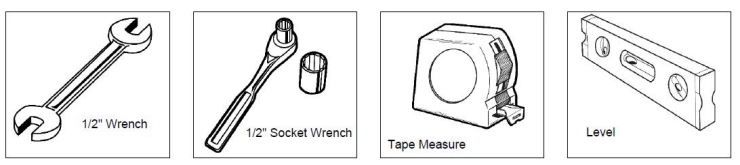

**Diamond Pattern Seat Example**



**Assembly Instructions:**

Attach the 10' Seat to the 942 legs as shown using specified hardware.

**WARRANTY:** OCCOutdoors, Inc. guarantees all items for one full year to be free of defects in workmanship or materials when installed and maintained properly. We agree to repair or replace, any items determined to be defective. Items specifically not covered by this warranty include vandalism, manmade or natural disasters, lack of maintenance, normal weathering or wear and tear due to public abuse.

**NOTES:**

1. INSTALLATION TO BE COMPLETED IN ACCORDANCE WITH MANUFACTURER'S SPECIFICATIONS.
2. ALL DIMENSIONS ARE CONSIDERED TRUE AND REFLECT MANUFACTURER'S SPECIFICATIONS
3. DO NOT SCALE DRAWING.

This document contains OCC Outdoors Proprietary Information. No intellectual copyright or license is granted by OCC Outdoors in connection with it. It is delivered on the express condition that the document and the information contained in it shall be treated as confidential, shall not be used for and purpose other than that for which it is hereby delivered (the use and maintenance of the product supplied). It shall not be disclosed in whole or part to third parties and shall not be duplicated in any manner without OCC Outdoors's prior approval.

**OCC Outdoors Products**

PH: 1-800-821-7670  
 EMAIL - occcontact@occoutdoors.com Fax:  
 1-317-862-9422

**Part #: OCC-942SM-DV10**

Date: 12/17/2015

**OCC Outdoors Deluxe 10' Bench W/O Back, 15" Plank, Surface Mount, Diamond Pattern Seat**

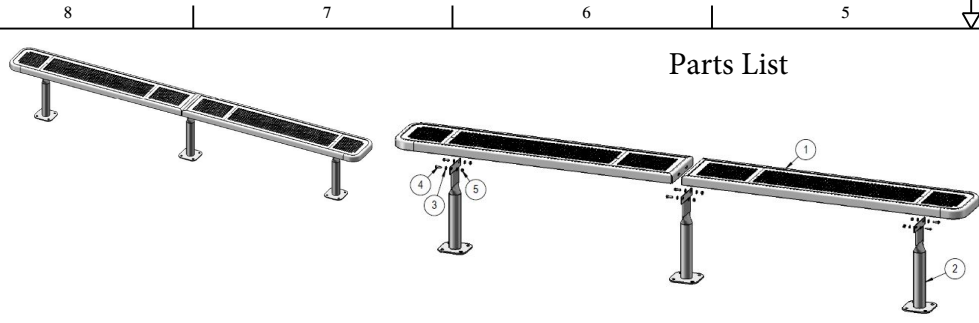

**Parts List**

ITEM NO.	PartNo	DESCRIPTION	QTY
1	T-DP60-S	10' Deluxe Punched Seat (1/2)	2
2	P-V942SM	942SM VINYL LEG	3
3	33-02-0007	5/16" Flat Washer (SS)	12
4	33-05-0029	5/16" x 1" Machine Bolt (SS)	6
5	33-03-0012	5/16" Kep Nut (SS)	6

**Hardware Included**

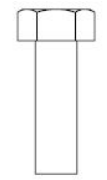

5/16" x 1" Machine Bolt

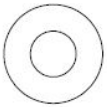

5/16" Washer



5/16" Kep Nut

**Tools Required**

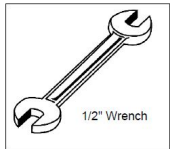

1/2" Wrench

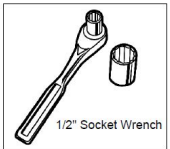

1/2" Socket Wrench

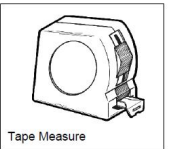

Tape Measure

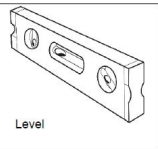

Level

**Assembly Instructions:**

Attach the 10' Seat to the 942 legs as shown using specified hardware.

**Mounting Instructions:**

**Recommended Surface Mount Hardware: 3/8" x 3-1/2" Concrete Expansion Anchor Bolts. (Not Included)**

**Dimensions**

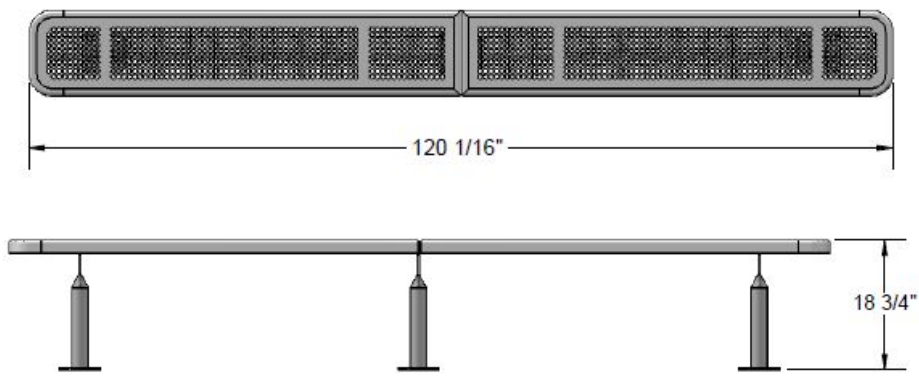

**Perforated Seat Example**

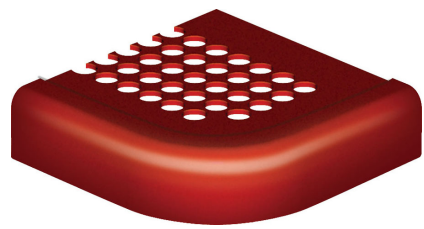

**WARRANTY:** OCCOutdoors, Inc. guarantees all items for one full year to be free of defects in workmanship or materials when installed and maintained properly. We agree to repair or replace, any items determined to be defective. Items specifically not covered by this warranty include vandalism, manmade or natural disasters, lack of maintenance, normal weathering or wear and tear due to public abuse.

**NOTES:**

1. INSTALLATION TO BE COMPLETED IN ACCORDANCE WITH MANUFACTURER'S SPECIFICATIONS.
2. ALL DIMENSIONS ARE CONSIDERED TRUE AND REFLECT MANUFACTURER'S SPECIFICATIONS
3. DO NOT SCALE DRAWING.

**OCC Outdoors Products**

PH: 1-800-821-7670  
 EMAIL - occcontact@occoutdoors.com Fax:  
 1-317-862-9422

**OCC Outdoors Deluxe 10'  
 Bench W/O Back, 15"  
 Plank, Surface Mount,  
 Perforated Pattern Seat**

**Part #: OCC-942SM-DP10**

Date: 12/17/2015

Page 1 of 1

This document contains OCC Outdoors Proprietary Information. No intellectual copyright or license is granted by OCC Outdoors in connection with it. It is delivered on the express condition that the document and the information contained in it shall be treated as confidential, shall not be used for and purpose other than that for which it is hereby delivered (the use and maintenance of the product supplied). It shall not be disclosed in whole or part to third parties and shall not be duplicated in any manner without OCC Outdoors's prior approval.