

Included Hardware

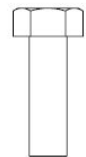

5/16" x 1" Machine Bolt



5/16" Washer



5/16" Kee Nut

Parts List

ITEM NO.	PartNo	DESCRIPTION	QTY.
1	T-V60-S	10' Expanded Seat (1/2)	2
2	P-V942WM	942 Wall Mount Leg Assembly	3
3	33-02-0007	5/16" SS Washer	24
4	33-05-0029	5/16" x 1" Machine Bolt (SS)	12
5	33-03-0012	5/16" Kee Nut (SS)	12

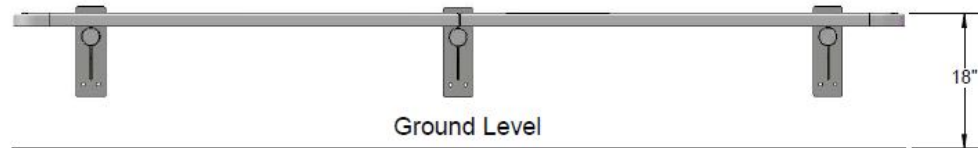

Assembly Instructions

Attach the 10' Seats to the 942 Legs as shown using specified hardware.

Tools Required

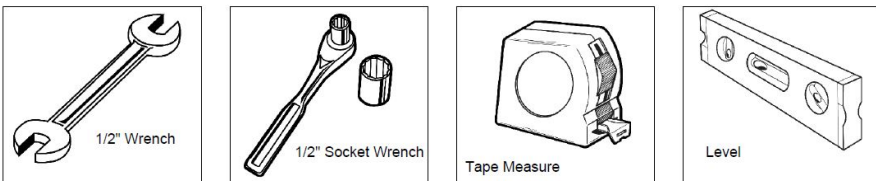

Diamond Seat Example

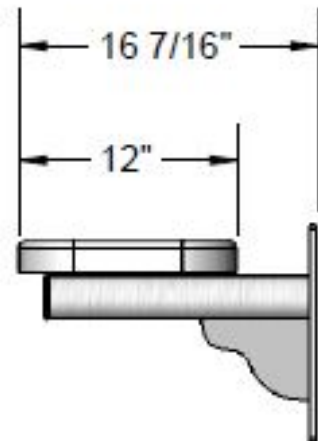

WARRANTY: OCCOutdoors, Inc. guarantees all items for one full year to be free of defects in workmanship or materials when installed and maintained properly. We agree to repair or replace, any items determined to be defective. Items specifically not covered by this warranty include vandalism, manmade or natural disasters, lack of maintenance, normal weathering or wear and tear due to public abuse.

NOTES:

1. INSTALLATION TO BE COMPLETED IN ACCORDANCE WITH MANUFACTURER'S SPECIFICATIONS.
2. ALL DIMENSIONS ARE CONSIDERED TRUE AND REFLECT MANUFACTURER'S SPECIFICATIONS
3. DO NOT SCALE DRAWING.

This document contains OCC Outdoors Proprietary Information. No intellectual copyright or license is granted by OCC Outdoors in connection with it. It is delivered on the express condition that the document and the information contained in it shall be treated as confidential, shall not be used for and purpose other than that for which it is hereby delivered (the use and maintenance of the product supplied). It shall not be disclosed in whole or part to third parties and shall not be duplicated in any manner without OCC Outdoors's prior approval.

OCC Outdoors Products

PH: 1-800-821-7670

EMAIL - occcontact@occoutdoors.com Fax:

1-317-862-9422

**OCC Outdoors 10' Bench
W/O Back, 12" Plank, Wall
Mount, Diamond Seat
Pattern**

Part #: OCC-942WM-V10

Date: 12/8/15

Page 1 of 1

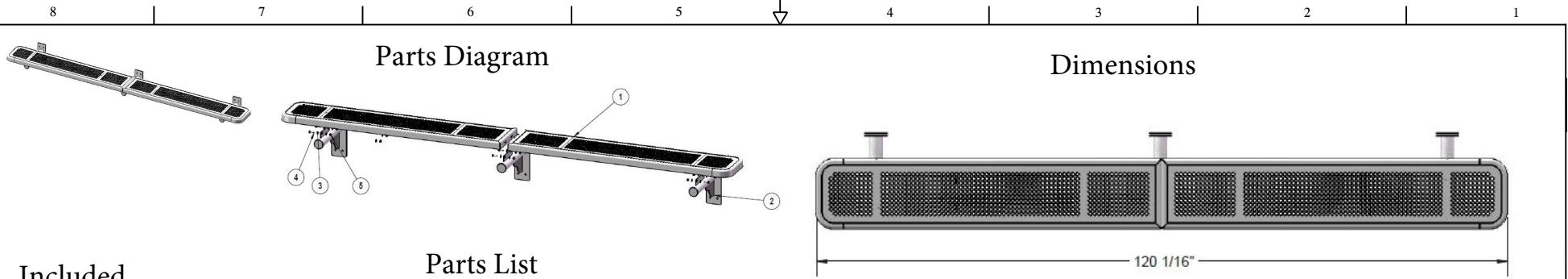

Included Hardware

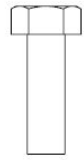

5/16" x 1" Machine Bolt



5/16" Washer



5/16" Keps Nut

Parts List

ITEM NO.	PartNo	DESCRIPTION	QTY.
1	T-P60-S	10' Punched Seat (1/2)	2
2	P-V942WM	942 Wall Mount Leg Assembly	3
3	33-02-0007	5/16" SS Washer	24
4	33-05-0029	5/16" x 1" Machine Bolt (SS)	12
5	33-03-0012	5/16" Keps Nut (SS)	12

Assembly Instructions

Attach the 10' Seats to the 942 Legs as shown using specified hardware.

Tools Required

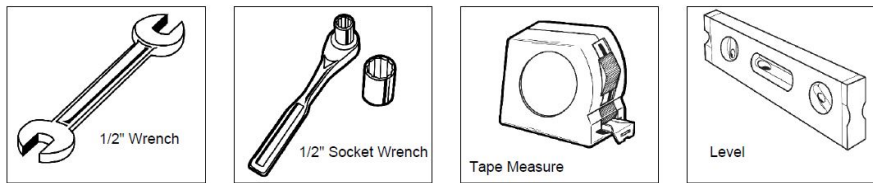

Perforated Seat Example

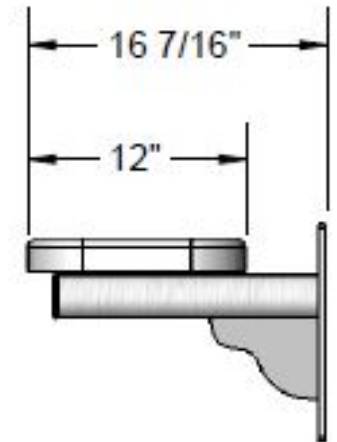
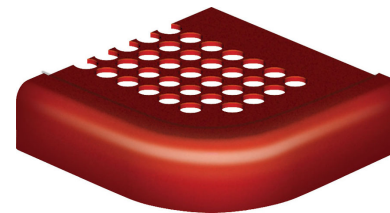

WARRANTY: OCCOutdoors, Inc. guarantees all items for one full year to be free of defects in workmanship or materials when installed and maintained properly. We agree to repair or replace, any items determined to be defective. Items specifically not covered by this warranty include vandalism, manmade or natural disasters, lack of maintenance, normal weathering or wear and tear due to public abuse.

- NOTES:**
1. INSTALLATION TO BE COMPLETED IN ACCORDANCE WITH MANUFACTURER'S SPECIFICATIONS.
 2. ALL DIMENSIONS ARE CONSIDERED TRUE AND REFLECT MANUFACTURER'S SPECIFICATIONS
 3. DO NOT SCALE DRAWING.

This document contains OCC Outdoors Proprietary Information. No intellectual copyright or license is granted by OCC Outdoors in connection with it. It is delivered on the express condition that the document and the information contained in it shall be treated as confidential, shall not be used for and purpose other than that for which it is hereby delivered (the use and maintenance of the product supplied). It shall not be disclosed in whole or part to third parties and shall not be duplicated in any manner without OCC Outdoors's prior approval.

OCC Outdoors Products
 PH: 1-800-821-7670
 EMAIL - occcontact@occoutdoors.com Fax:
 1-317-862-9422

Part #: OCC-942WM-P10

Date: 12/8/15

**OCC Outdoors 10' Bench
 W/O Back, 12" Plank, Wall
 Mount, Perforated Seat
 Pattern**

Page 1 of 1