

Parts List/Diagram

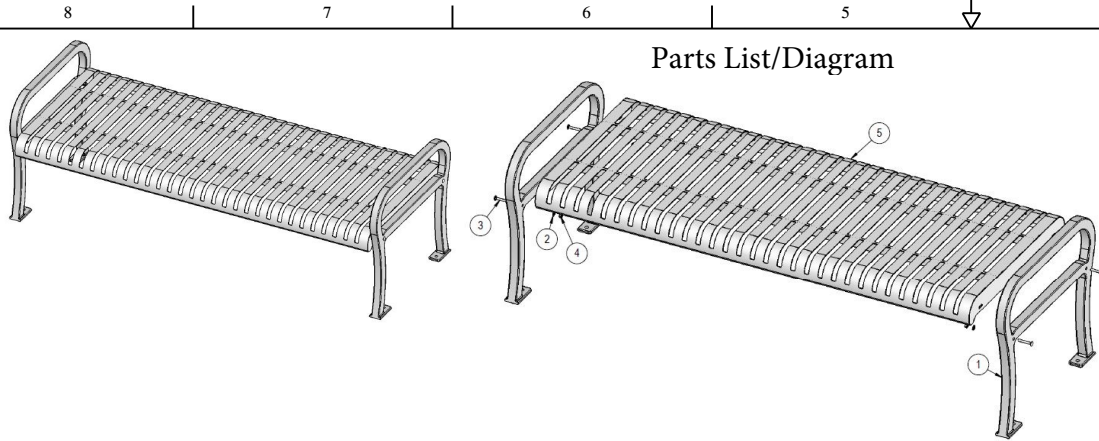

Dimensions

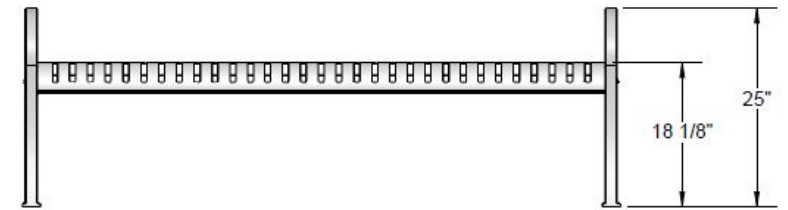
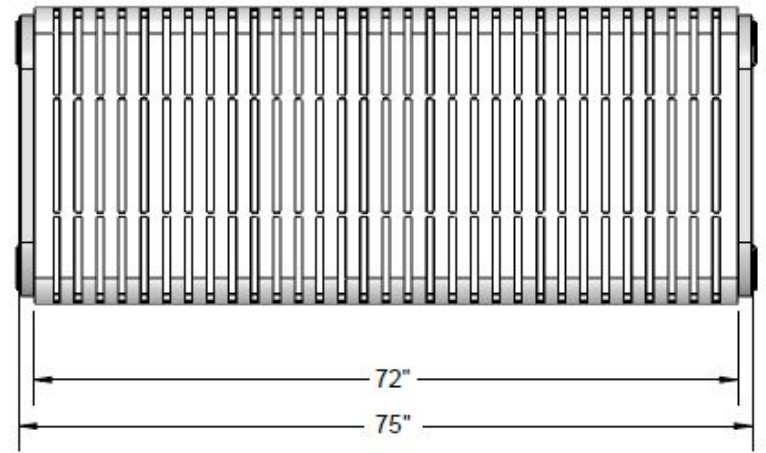

ITEM NO.	PartNo	DESCRIPTION	QTY
1	T-11-01-CAST2	958 Casted Aluminum Frame	2
2	33-02-0007	5/16" Flat Washer (SS)	4
3	33-06-0053	5/16" x 2-1/4" Carriage Bolt (SS)	4
4	33-03-0012	5/16" Keps Nut (SS)	4
5	T-S72FCT-S	6' Slat Flat Contour	1

Tools Required

5/16" x 2-1/4" Carriage Bolt



5/16" Washer



5/16" Keps Nut

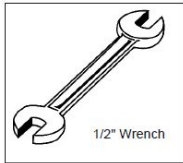

1/2" Wrench

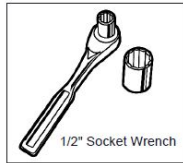

1/2" Socket Wrench

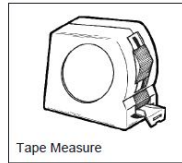

Tape Measure

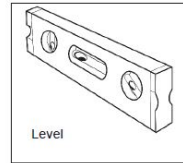

Level

Recommended Surface Mount Hardware:
3/8" x 3-1/2" Concrete Expansion Anchor Bolts
(Not Included)

Punched Steel Slat
 Pattern Seat



Assembly Instructions

Attach the 6' Flat Contour Seat to the 958 Legs using specifeid hardware.

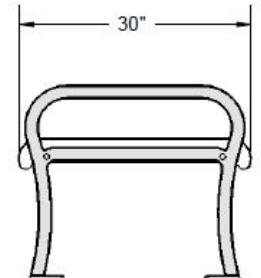

WARRANTY: OCCOutdoors, Inc. guarantees all items for one full year to be free of defects in workmanship or materials when installed and maintained properly. We agree to repair or replace, any items determined to be defective. Items specifically not covered by this warranty include vandalism, manmade or natural disasters, lack of maintenance, normal weathering or wear and tear due to public abuse.

NOTES:

1. INSTALLATION TO BE COMPLETED IN ACCORDANCE WITH MANUFACTURER'S SPECIFICATIONS.
2. ALL DIMENSIONS ARE CONSIDERED TRUE AND REFLECT MANUFACTURER'S SPECIFICATIONS
3. DO NOT SCALE DRAWING.

This document contains OCC Outdoors Proprietary Information. No intellectual copyright or license is granted by OCC Outdoors in connection with it. It is delivered on the express condition that the document and the information contained in it shall be treated as confidential, shall not be used for and purpose other than that for which it is hereby delivered (the use and maintenance of the product supplied). It shall not be disclosed in whole or part to third parties and shall not be duplicated in any manner without OCC Outdoors's prior approval.

OCC Outdoors Products

PH: 1-800-821-7670
 EMAIL - occcontact@occoutdoors.com
 Fax: 1-317-862-9422

OCC Outdoors 6' Backless Lexington Bench, Thermoplastic Coated Finish, Slat Pattern Seat, Can Be Surface Mounted or Portable

Part #: OCC-958-S6

Date: 3/30/2016 Page 1 of 1