

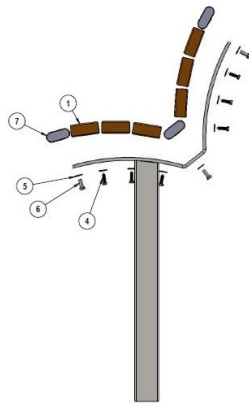

Parts List

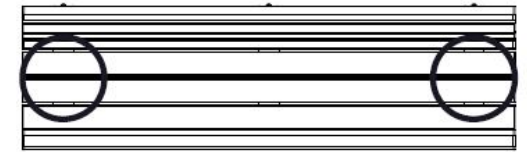

Footing Details

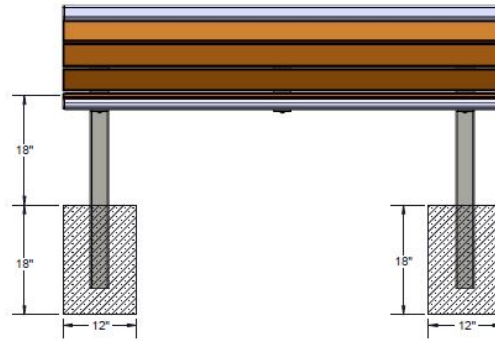

Estimated Required Concrete:
7 - 50lb Bags of Concrete Mix

Tools Required

Included Hardware

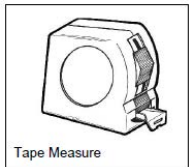
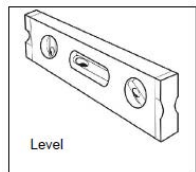
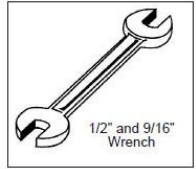
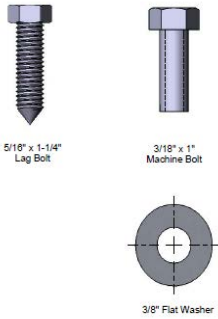

Attach the 6' Recycled and Aluminum Planks to the 61 Frames using specified hardware.

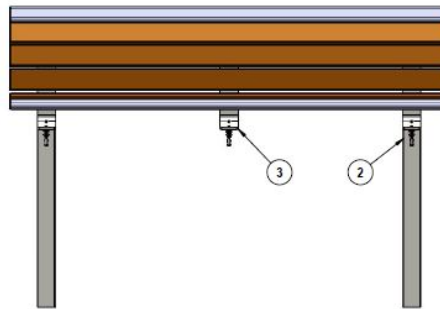

Dimensions



ITEM NO.	PartNo	DESCRIPTION	Qty.
1	BRN72-2x4-LB, CDR72-2x4-LB, GRN72-2x4-LB, or GRY72-2x4-LB	2 x 4 Brown Recycled Bench Plank-Lag Bolts (6), 2 X 4 Cedar Recycled Bench Plank-Lag Bolts (6), 2 x 4 Green Recycled Bench Plank-Lag Bolts(6), or 2 x 4 Grey Recycled Bench Plank-Lag Bolts (6)	6
2	P-01-01-0390	61 Series S Leg	2
3	P-01-01-0387	61 Series Bommerang	1
4	33-05-0034	5/16" x 1-1/4" lag bolt, SS	18
5	33-02-0008	3/8" Flat Washer (SS)	27
6	33-06-0056	3/8" x 1" Machine Bolt (SS)	9
7	P-01-01-0535	6' Oval Alum Tube Plank	3

WARRANTY: OCCOutdoors, Inc. guarantees all items for one full year to be free of defects in workmanship or materials when installed and maintained properly. We agree to repair or replace, any items determined to be defective. Items specifically not covered by this warranty include vandalism, manmade or natural disasters, lack of maintenance, normal weathering or wear and tear due to public abuse.

NOTES:

1. INSTALLATION TO BE COMPLETED IN ACCORDANCE WITH MANUFACTURER'S SPECIFICATIONS.
2. ALL DIMENSIONS ARE CONSIDERED TRUE AND REFLECT MANUFACTURER'S SPECIFICATIONS
3. DO NOT SCALE DRAWING.

OCC Outdoors Products

PH: 1-800-821-7670
EMAIL - occontact@occoutdoors.com
Fax: 371-862-9422

Part #: OCC-61S

Date: 8/28/2015

OCC-61SM In-Ground Mount
Richmond Series 6' Bench with
Black Steel Frame and choice of
4 slat colors.

This document contains OCC Outdoors Proprietary Information. No intellectual copyright or license is granted by OCC Outdoors in connection with it. It is delivered on the express condition that the document and the information contained in it shall be treated as confidential, shall not be used for and purpose other than that for which it is hereby delivered (the use and maintenance of the product supplied). It shall not be disclosed in whole or part to third parties and shall not be duplicated in any manner without OCC Outdoors's prior approval.