

### Assembly/Installation

### Overall Dimensions

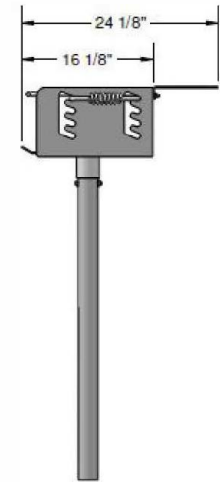
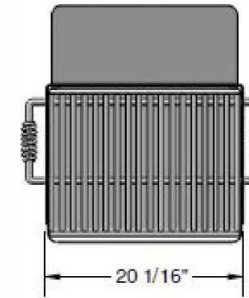
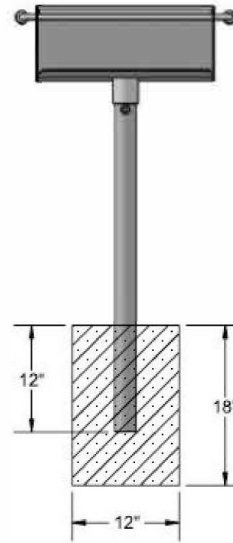

Estimated Required Concrete:  
4 - 50lb Bags of Concrete Mix

Attach the Grill Box to the 2-3/8" Post using specified hardware. Then attach the Utility Shelf to the Grill Box using specified hardware.

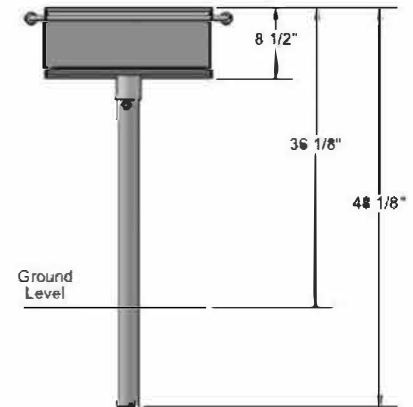

### Tools

### Required

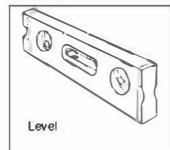
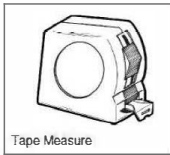
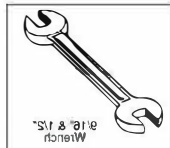

### Hardware Included

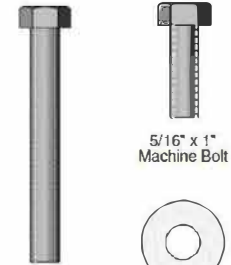

ITEM NO.	Part No	DESCRIPTION	QTY
1	620	620 Grill Box	1
2	01-03-0087	3 1/2" x 40" Grill Post	1
3	33-02-0002	3/8" Zinc Plated Washer	2
4	33-02-0001	5/16" Zinc Plated Washer	4
5	33-05-0008	3/8" x 3" Machine Bolt (Zinc)	1
6	33-05-0001	5/16" x 1" Machine Bolt (Zinc)	2
7	33-01-0002	3/8" Hex Nut (Zinc)	1
8	33-01-0001	5/16" Hex Nut (Zinc)	2
9	01-03-0010	Grill Utility Shelf	1

**WARRANTY:** OCCOutdoors, Inc. guarantees all items for one full year to be free of defects in workmanship or materials when installed and maintained properly. We agree to repair or replace, any items determined to be defective. Items specifically not covered by this warranty include vandalism, manmade or natural disasters, lack of maintenance, normal weathering or wear and tear due to public abuse.

### NOTES:

1. INSTALLATION TO BE COMPLETED IN ACCORDANCE WITH MANUFACTURER'S SPECIFICATIONS.
2. ALL DIMENSIONS ARE CONSIDERED TRUE AND PERFECT MANUFACTURER'S SPECIFICATIONS
3. DO NOT SCALE DRAWING.

### OCC Outdoors Products

PH: 1-800-821-7670

EMAIL - [occccontact@occcoutdoors.com](mailto:occccontact@occcoutdoors.com)

Fax: 1-317-862-9422

**Part #: OCC-620-3-U** Rotating Pedestal Grill w/3 1/2" OD post and 28 Sq. Inch Cooking Area and Utility Shelf

Date: 8/05/2015

This document contains OCC Outdoors Proprietary Information. No intellectual copyright or license is granted by OCC Outdoors in connection with it. It is delivered on the express condition that the document and the information contained in it shall be treated as confidential, shall not be used for any purpose other than that for which it is hereby delivered (the use and maintenance of the product supplied). It shall not be disclosed in whole or part to third parties and shall not be duplicated in any manner without OCC Outdoors's prior approval.