

Assembly/Installation

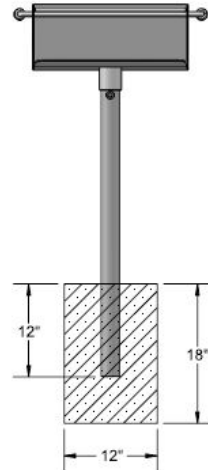

Overall Dimensions

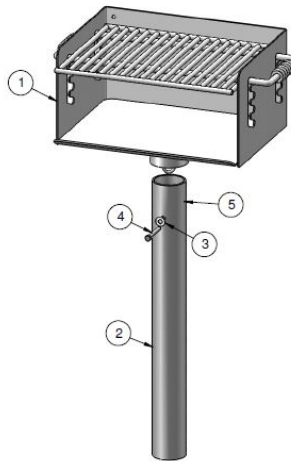
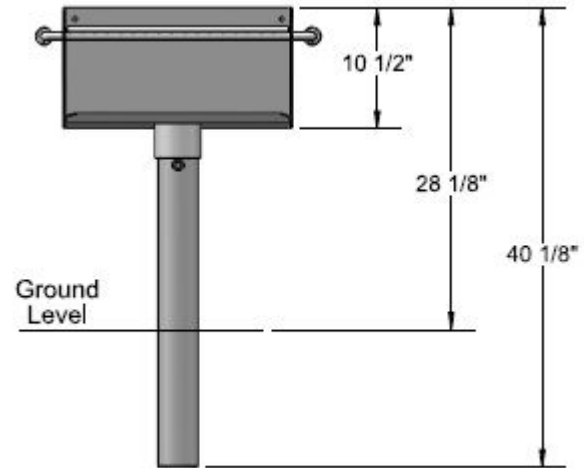
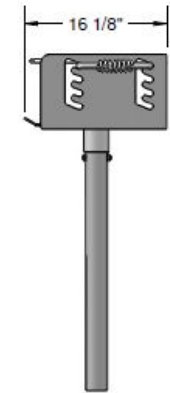
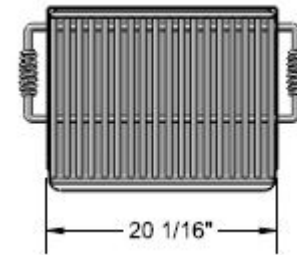

Tools Required

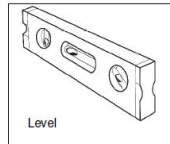
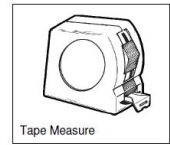
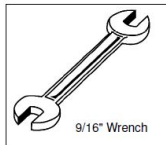

Hardware Included

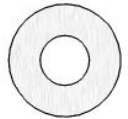

3/8" x 3" Machine Bolt

3/8" Washer

3/8" Hex Nut

ITEM NO.	Part No	DESCRIPTION	QTY
1	630-3	630-3 Grill Box	1
2	01-03-0085	3-1/2" x 30" H Grill Post	1
3	33-02-0002	3/8" Zinc Plated Washer	2
4	33-05-0008	3/8" x 3" Machine Bolt (zinc)	1
5	33-01-0002	3/8" Hex Nut (Zinc)	1

Attach the Grill Box to the 3-1/2" Post using specified hardware.

**Estimated Required Concrete:
4 - 50lb Bags of Concrete Mix**

WARRANTY: OCCOutdoors, Inc. guarantees all items for one full year to be free of defects in workmanship or materials when installed and maintained properly. We agree to repair or replace, any items determined to be defective. Items specifically not covered by this warranty include vandalism, manmade or natural disasters, lack of maintenance, normal weathering or wear and tear due to public abuse.

- NOTES:
 1. INSTALLATION TO BE COMPLETED IN ACCORDANCE WITH MANUFACTURER'S SPECIFICATIONS.
 2. ALL DIMENSIONS ARE CONSIDERED TRUE AND REFLECT MANUFACTURER'S SPECIFICATIONS
 3. DO NOT SCALE DRAWING.

This document contains OCC Outdoors Proprietary Information. No intellectual copyright or license is granted by OCC Outdoors in connection with it. It is delivered on the express condition that the document and the information contained in it shall be treated as confidential, shall not be used for and purpose other than that for which it is hereby delivered (the use and maintenance of the product supplied). It shall not be disclosed in whole or part to third parties and shall not be duplicated in any manner without OCC Outdoors's prior approval.

OCC Outdoors Products
 PH: 1-800-821-7670
 EMAIL - occcontact@occoutdoors.com
 Fax: 1-317-862-9422

Part #: OCC-630H-3

Date: 8/05/2015

ADA Compliant (Wheelchair Accessible) Rotating Pedestal Grill w/3 1/2" OD post and 300 Sq. Inch Cooking Area